

ROCKTOOLS  
**L45**  
AUSTRALIA

# PRODUCT CATALOGUE

## Underground Production Tube Drilling

T38  
T45



*Committing to a sustainable  
mining environment*

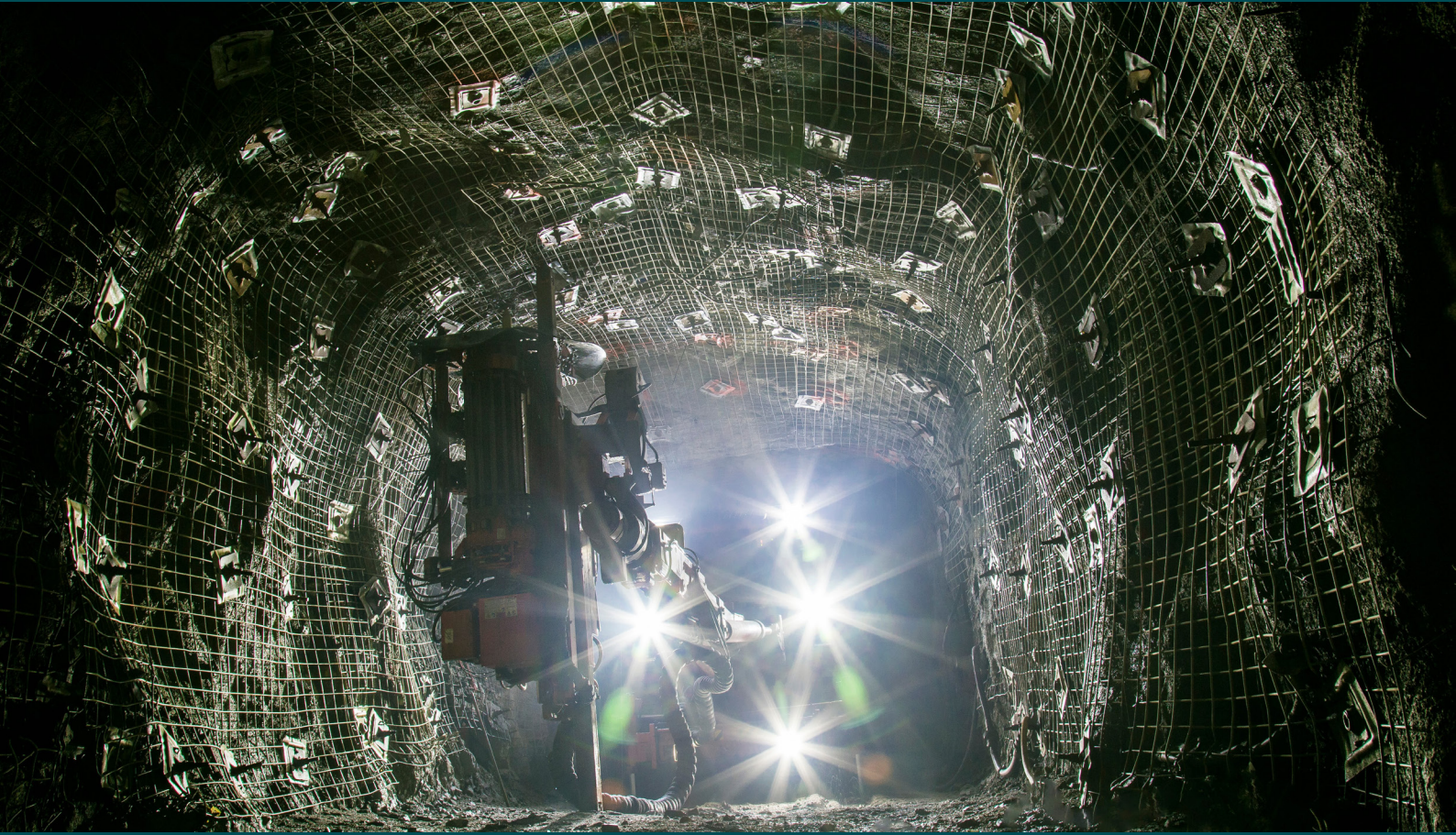



## T38 & T45 - Underground Production Tube Drilling







## T38 Shank Adaptors

	DRIFTER	LENGTH (mm)	OD (mm)	LHS P/N
<b>Sandvik/Tamrock, T38</b>				
	HL500S HL510S	500	38	QW16-500T38-HK
	HLX5PE	575	45	QW-63-5L-HK
	HL650 HL700 HL710 HL810 HL820	600	52	QW-59-3L-HK



## T38 Shank Adaptors

	DRIFTER	LENGTH (mm)	OD (mm)	LHS P/N
<b>Epiroc/COP, T38</b>				
	COP1440 COP1551 COP1838	525	52	QW-33-5L-HK
	COP1838EX	730	60	QW-55-4L-HK
	COP1838MUX	730	52	QW119-730T38-HK



## T38 Drill Tubes

	LENGTH (mm)	OD (mm)	LHS P/N
<b>Drill Tube, T38 Female – T38 Male</b>			
	1220	56	KYG56T38G-12L
	1525	56	KYG56T38G-15L
	1830	56	KYG56T38G-18L



## T38 Shoulder Drive Button Bits

Drill bits are available in **spherical**, **ballistic** and **semi-ballistic** carbide shapes.

	Size (mm)	Buttons * Size (mm)		Flushing		LHS P/N
		Gauge	Face	Side	Face	

### 6-Gauge Button Bits, Drop Centre, Regular Skirt, T38



64

6\*10

3\*10, 1\*9

0

3

ZQA64DG-T38

### 6-Gauge Button Bits, Drop Centre, Retrac Skirt, T38



64

6\*10

3\*10, 1\*9

0

3

ZYA64DG-T38

### 8-Gauge Button Bits, Drop Centre, Retrac Skirt, T38



64

8\*10

4\*10, 1\*10

0

4

ZYA64FG-T38

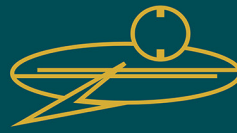

## T38 Reamers

*Pilot size is customisable for customers' requirements.*

	Reaming Size (mm)	Pilot Size (mm)	Buttons * Size (mm)	LHS P/N
<b>Reamer, One-piece, T38</b>				
	89	64	8*12, 2*10	ZQK89F/64-T38
	102	64	8*14, 4*10	ZQK102F2/64-T38
	127	64	14*14, 2*8	ZQK127F2/64-T38
	150	64	18*14, 3*10	ZQK150G1/64-T38



## T45 Shank Adaptors

	DRIFTER	LENGTH (mm)	OD (mm)	LHS P/N
--	---------	----------------	------------	---------

### Sandvik/Tamrock, T45



HLX5PE

575

45

QW-63-4L-HK



HL650

HL700

HL710

HL810

HL820

600

52

QW-59-1L-HK

### Epiroc/COP, T45



COP1838EX

730

60

QW-55-2L-HK



COP1838MUX

730

52

QW-119-1L-HK



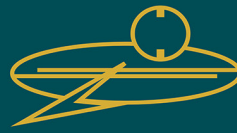

## T45 Drill Tubes

	LENGTH (mm)	OD (mm)	LHS P/N
<b>Drill Tube, T45 Female – T45 Male</b>			
	1830	65	KYG65T45G-18L



## T45 Shoulder Drive Button Bits

Drill bits are available in **spherical**, **ballistic** and **semi-ballistic** carbide shapes.

	Size (mm)	Buttons * Size (mm)		Flushing		LHS P/N
		Gauge	Face	Side	Face	

### 8-Gauge Button Bits, Flat Face, Regular Skirt, T45

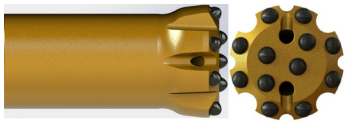

76

8\*12

4\*12

1

2

ZQ76FG-T45

### 8-Gauge Button Bits, Drop Centre, Regular Skirt, T45

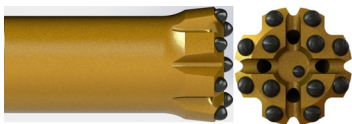

76

8\*11

4\*11, 1\*9

1

4

ZQA76F2G-T45

### 8-Gauge Button Bits, Drop Centre, Retrac Skirt, T45



76

8\*11

4\*11, 1\*9

0

4

ZYA76F2G-T45

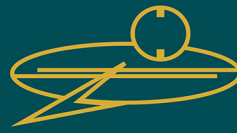

## T45 Reamers

*Pilot size is customisable for customers' requirements.*

	Reaming Size (mm)	Pilot Size (mm)	Buttons * Size (mm)	LHS P/N
<b>Reamer, One-piece, T45</b>				
	102	64	8*14, 6*10	ZQK102F/64-T45
	127	76	12/14, 2*9	ZQK127F2/67-T45
	150	76	15*14, 3*9	ZQK150G3/76-T45
	178	76	21*16, 3*9	ZQK178G/76-T45
	203	76	21*16, 3*8	ZQK203G1/76-T45
	203	140	15*16	ZQK203G/140-T45



## Auxiliary Tools

### Fishing Tool, Pike, Standard

	Thread	Length (mm)	OD (mm)	LHS P/N
	T38	180	60	PFT-T38
	T45	205	63	PFT-T45

### Fishing Tool, Pike, Long

	T38	205	60	PFT-T38-L
	T45	270	63	PFT-T45-2

### Fishing Tool, Sleeve, Standard

	T38	175	60	BT-T38
	T45	205	70	BT-T45

### Fishing Tool, Sleeve, Long

	T38	355	60	BT-T38L
	T45	395	70	BT-T45-71



## Contact Us

### LHS Rocktools – Perth (Head Office)

**Address:** 10 Bell Street, Kewdale, WA, 6105

**Phone:** (08) 9353 3288

**Email:** [info@lhsrta.com.au](mailto:info@lhsrta.com.au)

**Website:** [www.lhsrta.com.au](http://www.lhsrta.com.au)

### LHS Rocktools – Kalgoorlie

**Address:** 1-5 Kayili Road, Kalgoorlie, WA, 6430

**Phone:** (08) 9021 8566

### LHS Rocktools – Melbourne

**Address:** 41 North View Drive, Sunshine West, VIC, 3020

**Phone:** (03) 9312 3382

### LHS Rocktools – Charters Towers

**Address:** 28 Mt. Leyshon Road, Charters Towers, QLD, 4820

**Phone:** (07) 4787 8769

### LHS Rocktools – Cloncurry

**Address:** 77 Phillips Street, Cloncurry, QLD, 4824

**Phone:** (07) 4742 2714



ROCKTOOLS  
LHS  
AUSTRALIA

LHS ROCKTOOLS (AUSTRALIA) PTY LTD

+61 8 9353 3288

[info@lhsrta.com.au](mailto:info@lhsrta.com.au)

[www.lhsrta.com.au](http://www.lhsrta.com.au)